

Valves of stainless steel

# Reject-Valves

## TAP/G

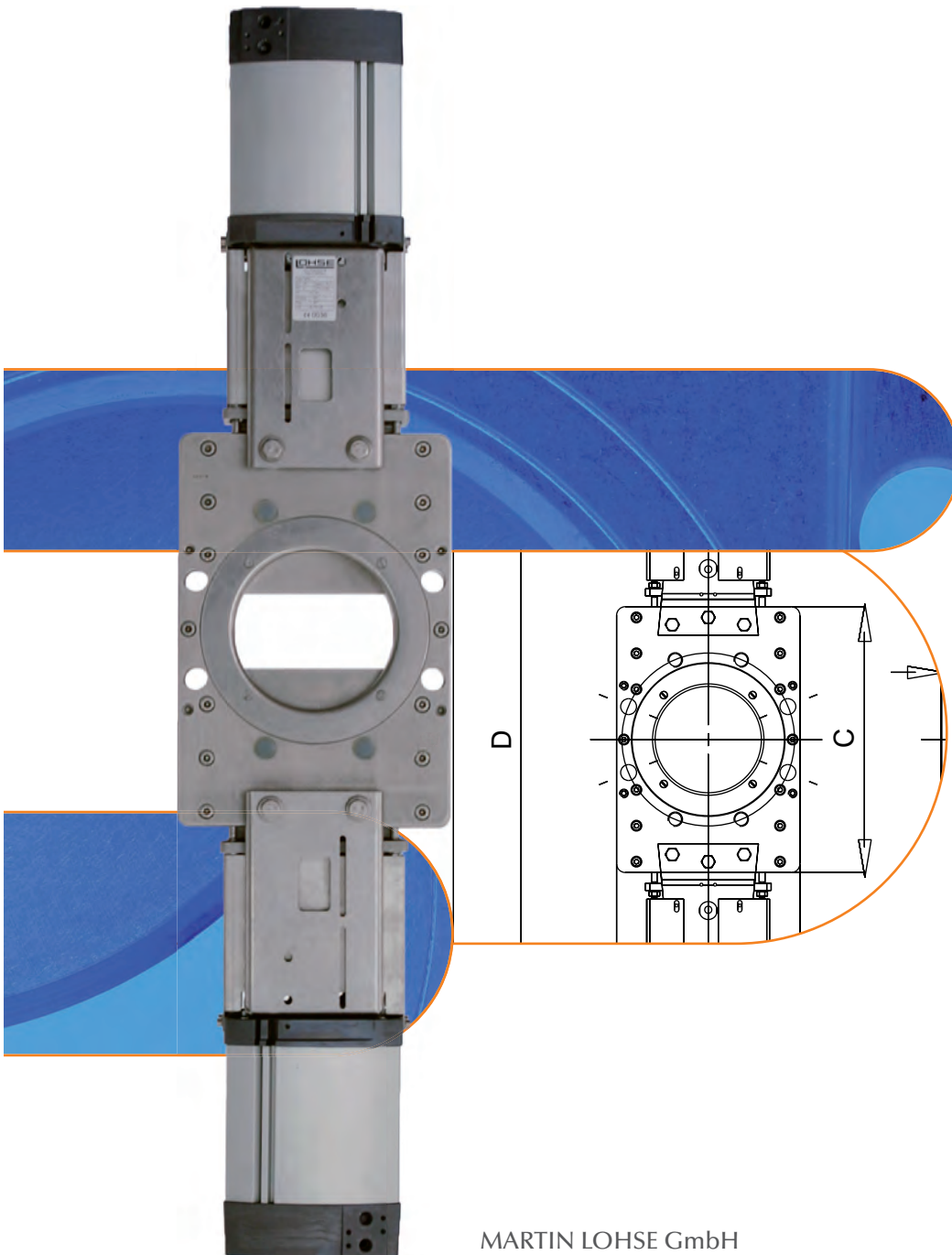

MARTIN LOHSE GmbH  
Unteres Paradies 63 · D-89522 Heidenheim  
Postfach 1565 · D-89505 Heidenheim  
phone +49(0)7321 / 755-42 · fax +49(0)7321 / 755-97  
server.ab@lohse-gmbh.de  
www.lohse-gmbh.de

## Applications

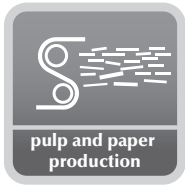

### General usage

- media with reject fraction (e.g. nails and staples)
- coarse-grained media
- granulates
- powders
- temperature range to 80 °C
- see table for permitted operating pressure

### Locations

- extraction devices for heavy soiling applications
- dumping and emptying devices for heavy soiling applications
- cleaning machines

## Media

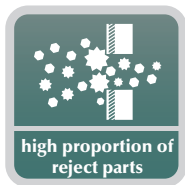

## Materials

- housing S355J2  
or  
1.4541
- flanging ring 1.4571
- valve plate 1.4571
- slide cups PE-UHMW (RCH1000)
- sealing EPDM
- stuffing box gland  
DN 100 – 500 1.4541  
DN 600 – 800 1.4301
- bracket S355 J2 (steel)  
or  
1.4541
- max. operating pressure  
DN 100 – 250 4 bar  
DN 300 – 800 2 bar
- max. operating temperature 80° C

Flange bores for LOHSE TA-valves according to DIN EN 1092-1, PN 10

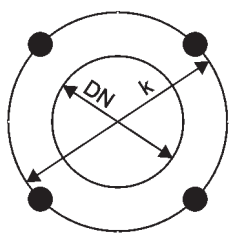

DN 50-65

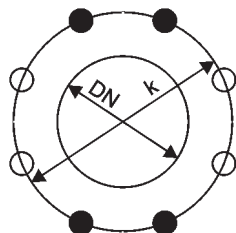

DN 80-200

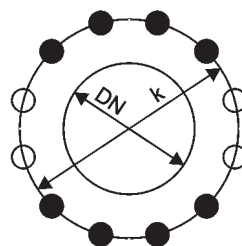

DN 250-300

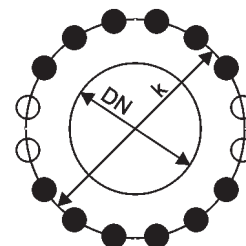

DN 350-400

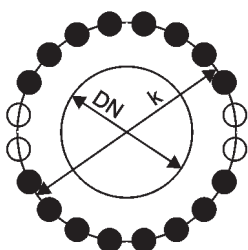

DN 450-600

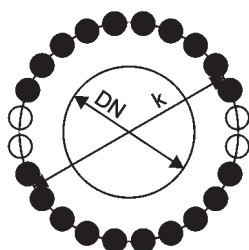

DN 700-800

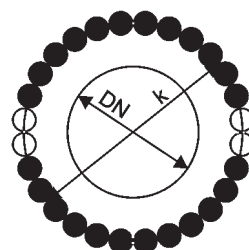

DN 900-1000

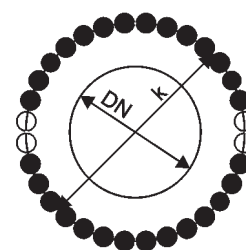

DN 1100-1200

DN [mm]	K [mm]	Z	M	T [mm]	Z1	Z2
50	125	4	M16	12	4	-
65	145	4	M16	12	4	-
80	160	8	M16	12	4	4
100	180	8	M16	12	4	4
125	210	8	M16	12	4	4
150	240	8	M20	16	4	4
200	295	8	M20	16	4	4
250	350	12	M20	20	8	4
300	400	12	M20	20	8	4
350	460	16	M20	20	12	4
400	515	16	M24	23	12	4
450	565	20	M24	30	16	4
500	620	20	M24	30	16	4
600	725	20	M27	35	16	4
700	840	24	M27	40	20	4
800	950	24	M30	45	20	4
900	1050	28	M30	45	24	4
1000	1160	28	M33	45	24	4
1100	1270	32	M33	50	28	4
1200	1380	32	M36	55	28	4

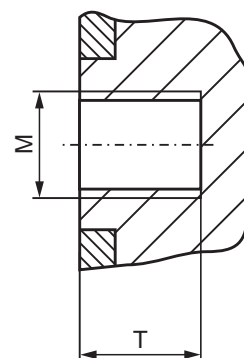

Z = total number of holes  
 Z1 = number of joint-holes  
 Z2 = number of through-going bores  
 T = usable depth of thread

Flange bores for LOHSE TA-valves  
according to ANSI B 16.5 Class 150 (≥ DN 700: ANSI B 16.47 Class 150)

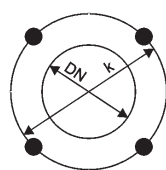

DN 50-80

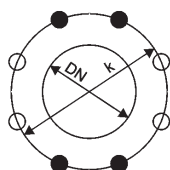

DN 100-200

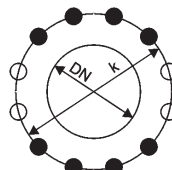

DN 250-350

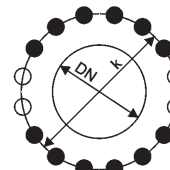

DN 400-450

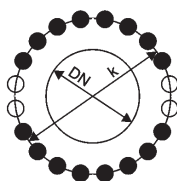

DN 500-600

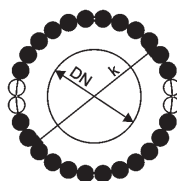

DN 700-800

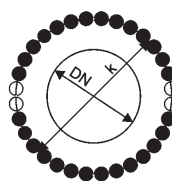

DN 900

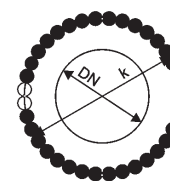

DN 1000

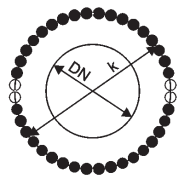

DN 1100

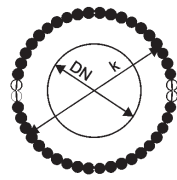

DN 1200

DN [mm]	DN [inch]	K [mm]	K [inch]	Z	UNC	T [mm]	T [inch]	Z1	Z2
50	2	120.6	4 3/4	4	5/8"-11	12	0.472	4	-
65	2.5	139.7	5 1/2	4	5/8"-11	12	0.472	4	-
80	3	152.4	6	4	5/8"-11	12	0.472	4	-
100	4	190.5	7 1/2	8	5/8"-11	12	0.472	4	4
125	5	215.9	8 1/2	8	3/4"-10	12	0.472	4	4
150	6	241.3	9 1/2	8	3/4"-10	16	0.630	4	4
200	8	298.5	11 3/4	8	3/4"-10	16	0.630	4	4
250	10	362	14 1/4	12	7/8"-9	20	0.787	8	4
300	12	431.8	17	12	7/8"-9	20	0.787	8	4
350	14	476.3	18 3/4	12	1"-8	20	0.787	8	4
400	16	539.8	21 1/4	16	1"-8	23	0.910	12	4
450	18	577.9	22 3/4	16	1 1/8"-7	30	1.181	12	4
500	20	635	25	20	1 1/8"-7	30	1.181	16	4
600	24	749.3	29 1/2	20	1 1/4"-7	35	1.378	16	4
700	28	863	34	28	1 1/4"-7	40	1.575	24	4
800	32	978	38 1/2	28	1 1/2"-6	45	1.772	24	4
900	36	1086	42 3/4	32	1 1/2"-6	45	1.772	28	4
1000	40	1200	47 1/4	36	1 1/2"-6	45	1.775	32	4
1100	44	1314	51 3/4	40	1 1/2"-6	50	1.969	36	4
1200	48	1422	56	44	1 1/2"-6	55	2.165	40	4

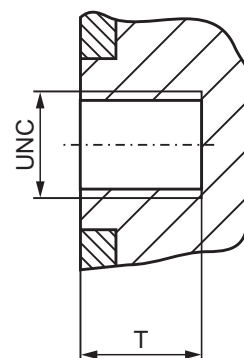

Z = total number of holes  
 Z1 = number of joint-holes  
 Z2 = number of through-going bores  
 T = usable depth of thread

## Reject-valve

two double-acting pneumatic cylinders and protection guard

Housing stainless steel or steel

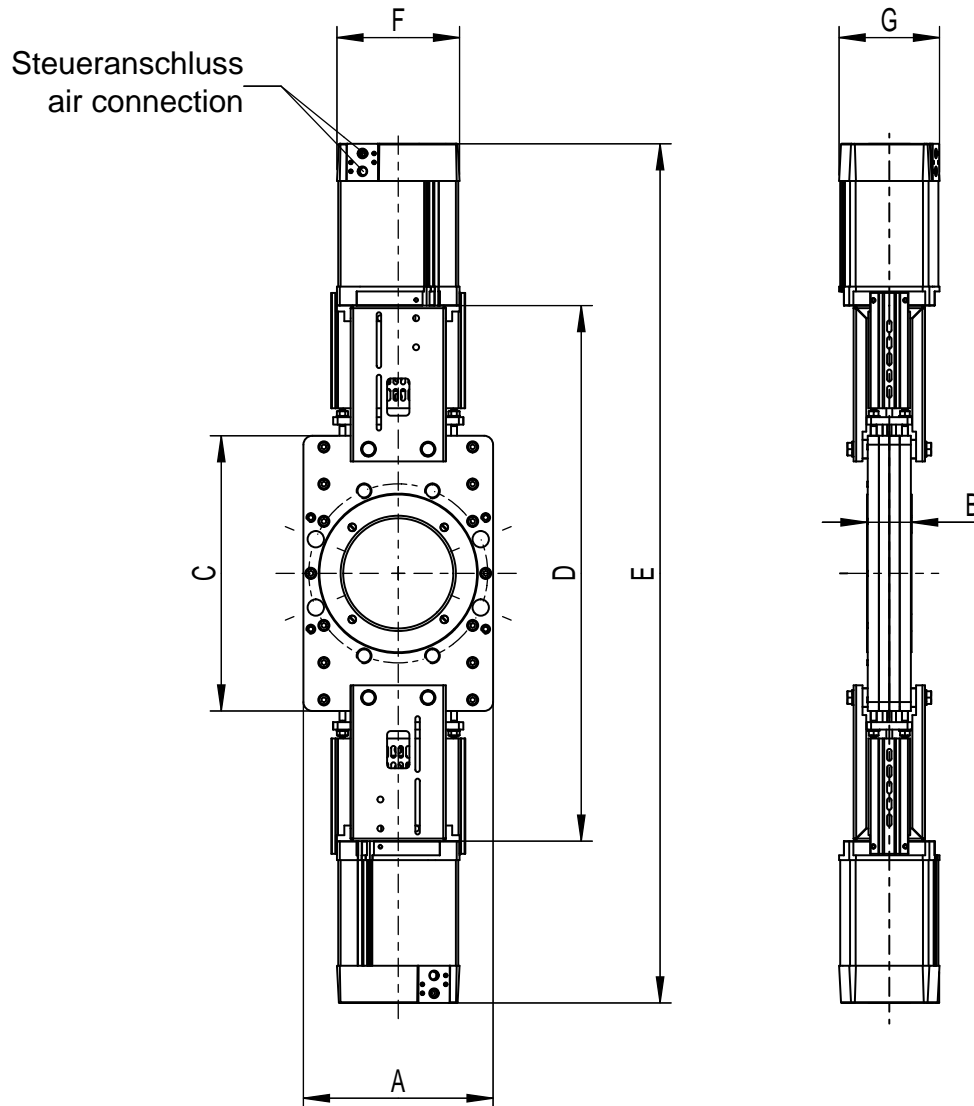

DN	PS [bar]	A	B	C	D	E	F	G	cyl Ø	air connection	weight ~[kg]
100	4	200	50	300	590	969	165	145	125	G 1/4"	33,9
125	4	230	50	325	640	1043	165	145	125	G 1/4"	37,2
150	4	255	60	370	720	1182	204	178	160	G 1/4"	53,5
200	4	310	60	460	870	1414	244	215	200	G 1/2"	84,6
250	4	380	70	550	1020	1614	244	215	200	G 1/2"	120,3
300	2	430	70	600	1126	1810	283	242	230	G 1/2"	159,2

Mounting only in vertical flow direction. Higher operating pressures on request.

Dimensions in mm, flange bores to DIN EN 1092-1, PN 10 or ANSI B 16.5 class 150; air connection acc. VDI/VDE 3845 (NAMUR). Further sizes on request.

## Reject-valve

two double-acting pneumatic cylinders and protection guard

Housing stainless steel or steel

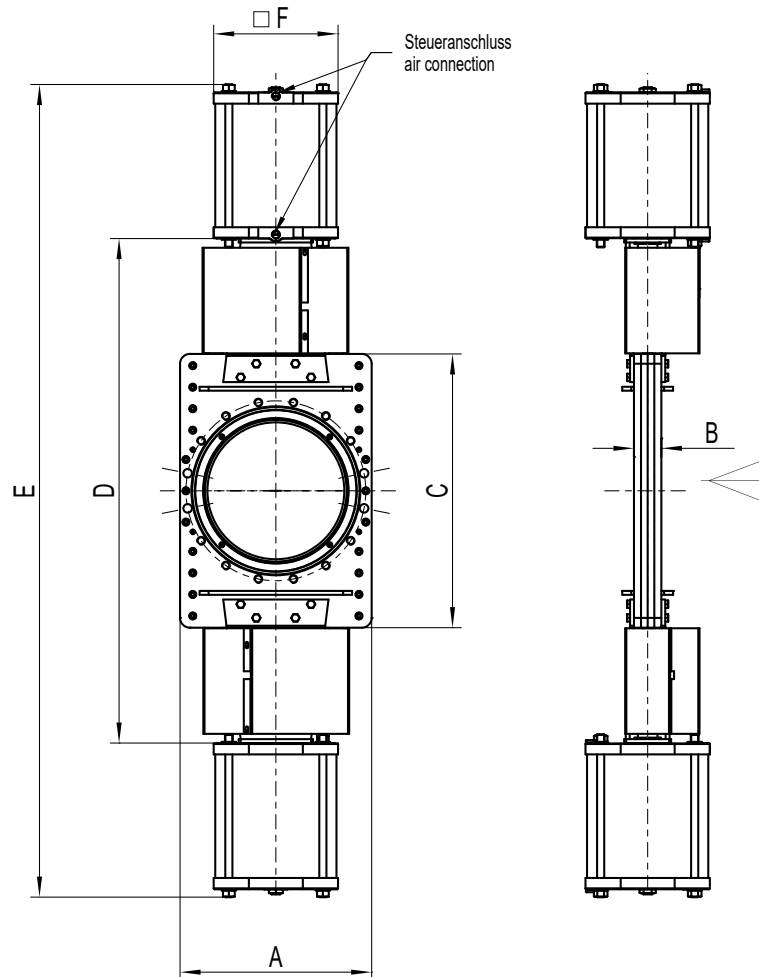

DN	PS [bar]	A	B	C	D	E	F	cyl Ø	air connection	weight ~[kg]
350	2	490	70	700	1290	2078	318	300	G 1/2"	
400	2	540	90	800	1578	2366	318	300	G 1/2"	300
450	2	600	110	900	1730	2574	318	300	G 1/2"	405
500	2	650	110	1100	2010	3060	425	400	G 3/4"	706
600	2	800	110	1300	2320	3482	425	400	G 1/2"	904
700	2	930	110	1500	2720	3974	425	400	G 3/4"	1370
800	2	1030	140	1750	3100	4382	645	500	G 3/4"	2335

Mounting only in vertical flow direction. Higher operating pressures on request.

Dimensions in mm, flange bores to DIN EN 1092-1, PN 10 or ANSI B 16.5 class 150 (≥ DN 700: ANSI B 16.47 class 150). Further sizes on request.

## Germany + Switzerland

**MARTIN LOHSE GmbH**  
Postfach 1565  
89505 Heidenheim  
Phone: +49 (0) 73 21 / 7 55-0  
Fax: +49 (0) 73 21 / 7 55-99  
server.ab@lohse-gmbh.de  
www.lohse-gmbh.de

## Australia, New Zealand, Indonesia, Singapore, Malaysia

**P.T. VOITH PAPER**  
Jl. Permata V Lot EE - 1  
Kawasan Industri KIIC  
Karawang 41361, INDONESIA  
Phone : +62 267 419 719  
Fax : +62 267 419 717

## Austria (pulp + paper industry, wastewater + wastewater treatment plants) + CZ, SK, SLO, SRB, HR, H

**Peter Reiter**  
Handel Mazzetti-Str. 85  
3100 St. Pölten  
Phone: +43 (0) 27 42 / 7 73 66  
Fax: +43 (0) 27 42 / 7 73 66  
office@industriearmaturen.at

## Austria

**Klinger Gebetsroither GmbH & Co KG**  
Am Kanal 8-10  
2352 Gumpoldskirchen  
Phone: +43 2252 60 71 00 3029  
Fax: +43 2252 60 71 00 3010  
gerhard.praxmarer@gebetsroither.at  
www.gebetsroither.at

## Belgium

**Hanwel Belgium N.V.**  
Winninglaan 15  
9140 Temse  
Phone: +32 (0) 3 / 7 11 03 53  
Fax: + 32 (0) 3 / 7 11 05 79  
info@hanwel.be  
www.hanwel.be

## Chile

**INTERTECH**  
Prat 116, Of 31  
Curicó, Chile  
phone +56.075.322033  
www.inter-tech.cl  
n.flores@inter-tech.cl

## People's Rep. Of China

**Shanghai Fier Mechanical Co. LTD**  
Room B4, 15/F HuaFu Bldg.  
No. 585 LongHua xi Rd.  
ShangHai, China 200232  
Phone: +86-21-54591038  
Fax: +86-21-54240616  
MP: 13611665381  
shfier@163.com  
www.fier.com.cn

## Denmark

**Uni-Valve A/S**  
Sydvestvej 138 – 140  
2600 Glostrup  
Phone: +45 (0) 43 43 82 00  
Fax: +45 (0) 43 43 74 75  
mail@uni-valve.com  
www.uni-valve.com

## Finland

**KLINGER Finland Oy**  
Tinankuja 3  
02430 Masala  
Phone: +358 (0) 10 400 10 11  
info@klinger.fi  
www.klinger.fi

## France, MA, TN, DZ

**T.N.P.**  
30 Boussegré  
58140 Lormes  
Phone: +33 (0) 1 / 55 97 11-11  
Fax: +33 (0) 1 / 48 83 52 07  
contact@tnp.fr  
www.tnp.fr

## Great Britain

**Voith Turbo Ltd.**  
6 Beddington Farm Road  
Croydon, Surrey CRO, 4XB  
Phone: +44 (0) 2 08 / 6 67 30 13  
Fax: +44 (0) 2 08 / 6 67 04 03  
matthew.healy@voith.com

## Greece

**Niko Mikopoulos, BSc.**  
Metron Str. 28  
17123 Nea Smyrni-Athens  
Phone: +30 6 98 305 10 70  
n.mikopoulos@nm-bc.com

## India

**Antrieb Technik Private Limited**  
59 (old 359) Sidco Industrial Estate  
Ambattur  
Chennai-600 098  
Tamilnadu / INDIA  
Phone: +91 (44) 262 – 58303  
Fax: +91 (44) 2819 – 3718  
antrieb.technik@gmail.com

## Israel

**P.B.A Wiesner Agencies Ltd.**  
P. O. Box 4622  
Petach-Tikva 49277  
Phone: +972 (0) 3 / 9 05 21 11  
Fax: +972 (0) 3 / 9 05 21 10  
ofra@pba.co.il

## Italy

**Techno Paper S.R.L.**  
Viale Certosa 269  
20151 Milano (MI)  
Phone: +39 (0) 02 78627750  
Fax: +39 (0) 02 45471638  
info@techno-paper.com  
www.techno-paper.com

## Japan

**Voith IHI Paper Technology Co.Ltd.**  
River City M-SQUARE 7F  
2-1-6 Tsukuda, Chuo-ku  
1040051 Tokyo  
Phone: +81 3 6221 3108  
Fax: +81 3 6221 3126

## Korea

**C.S-Automation Co., Ltd. (Customer Satisfaction Automation)**  
#804 Sejung Technovalley  
279-5 Songjeong-Dong  
Heungdeok-Gu  
Cheongju-Si  
South Korea. 361-290  
Phone: +82 43 276 1332  
Fax: +82 43 278 1332  
changseol@korea.com

## Netherlands

**Hanwel B. V.**  
Jan Tinbergenstraat 209  
7559 SP Hengelo  
The Netherlands  
Phone: +31 74-2650000  
Fax: +31 74-2650001  
verkoop@hanwel.com  
www.hanwel.com

## Norway

**KSB Norge AS**  
Haugenveien 29  
1400 SKI  
Phone: +47 96 900 900  
firmapost@ksb.com  
www.ksb.com/ksb-no

## Philippines

**R. Dan and Co., Inc.**  
20 Alfonso St.  
Rosario  
Pasig City 1609  
Phone: +632 – 6558796  
Fax: +632 – 6562089  
ester.poe@robertdan.com.ph  
www.robertdan.com.ph

## Poland

**Waldemar Kulicki**  
ul. Heweliusza 37/4  
87-148 Papowo Toruńskie  
Phone: +48 56 / 6783399  
Fax: +48 56/ 6783880  
waldemar-kulicki@wp.pl  
www.wkulicki.eu

## Rep. of South Africa

**Voith Turbo (Pty) Ltd**  
P.O. Box 13171  
Witfield, 1467  
Gauteng, SOUTH AFRICA  
Phone: +27 11 418 4000  
Fax: +27 11 418 4080  
info.vtza@voith.com  
www.rsa.voithturbo.com

## Spain, Portugal

**CELPAP EQUIPOS, S.L.**  
C/Amposta, 14-18  
08174 Sant Cugat del Vallés  
(Barcelona)  
Phone +34 93 415 18 75  
celpap@celpap.com  
www.celpap.com

## Sweden

**PA-Ventiler AB**  
Sagbäcksvägen 3B  
43736 Lindome  
Phone: +46 (0) 31 / 99 25 00  
Fax: +46 (0) 31 / 99 25 03  
info@paventiler.se  
www.paventiler.se

## Taiwan

**E-Chen Engineering Co., Ltd.**  
3F-3, No. 151, Sec. 4,  
Hsin-Yi Road,  
Taipei, Taiwan, R.O.C.  
Phone: +886 (0) 22 / 7056185  
Fax: +886 (0) 22 / 7 04 59 67  
echen123@ms15.hinet.net

## Thailand

**Weston Myer Ltd.**  
8 Soi Seri-Thai 58  
Seri-Thai Road  
10510 Minburi Bangkok  
Phone: +66 (0) 2 / 3 74 58 69  
Fax: +66 (0) 2 / 3 75 – 11 79  
comm1@westonmyer.com

## Turkey

**Sanrep Kağıt San. ve Tic. Ltd. Şti.**  
Altıyol, Kuşdili Caddesi No:19/7  
H.Fazlıoğlu İş Merkezi  
34714 Kadıköy – İSTANBUL  
Phone: +90 216 345 40 48  
Fax: +90 216 330 73 12  
sanrep@sanrep.com  
www.sanrep.com

## USA, Canada, Mexico

**Voith Paper Inc.**  
2200 N. Roemer Rd.  
Appleton, WI 54912-2237  
Phone: +1 920 – 358 – 2396  
Fax: +1 920 – 731 – 5126  
VPAWSPareParts@voith.com